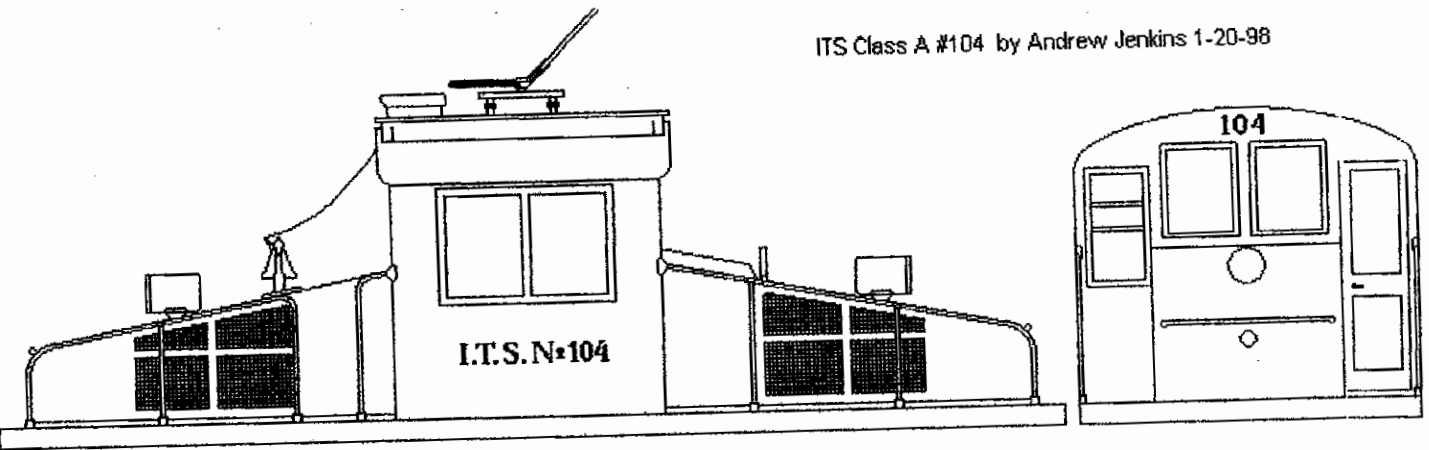

**TABLE OF CONTENTS**  
**Freight Motor Drawings**

<b><u>Page</u></b>	<b><u>Class</u></b>
2	A
7	B
11	C
13	D

ITS Class A #104 by Andrew Jenkins 1-20-98



ITS Class A #1560 by Andrew Jenkins 2-3-98

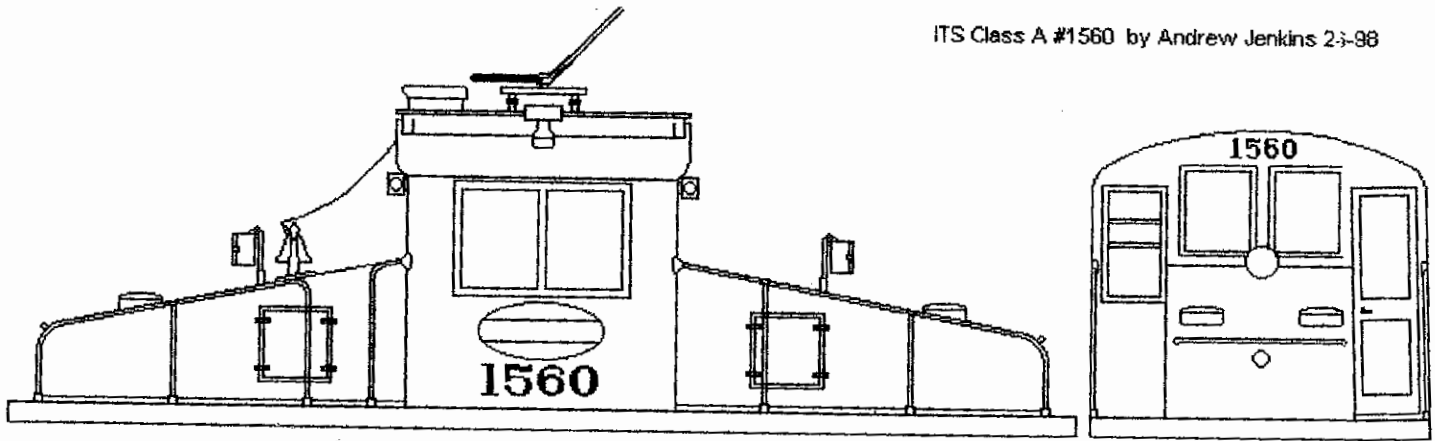

ITS class A #1553 by Andrew Jenkins 2-8-98

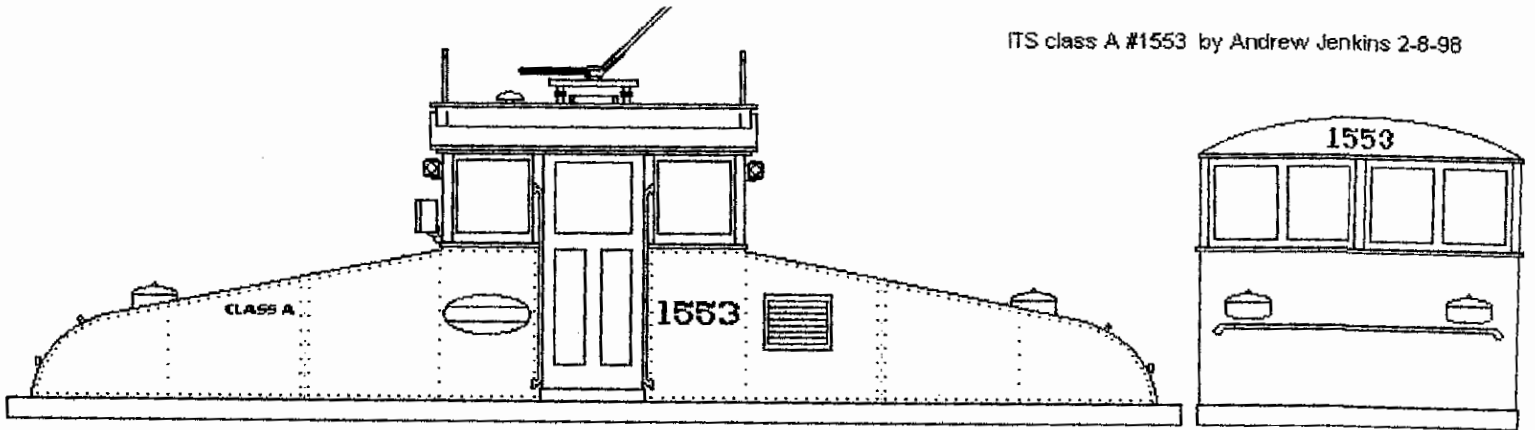

ITS Class O #1550 by Andrew Jenkins 1-26-98

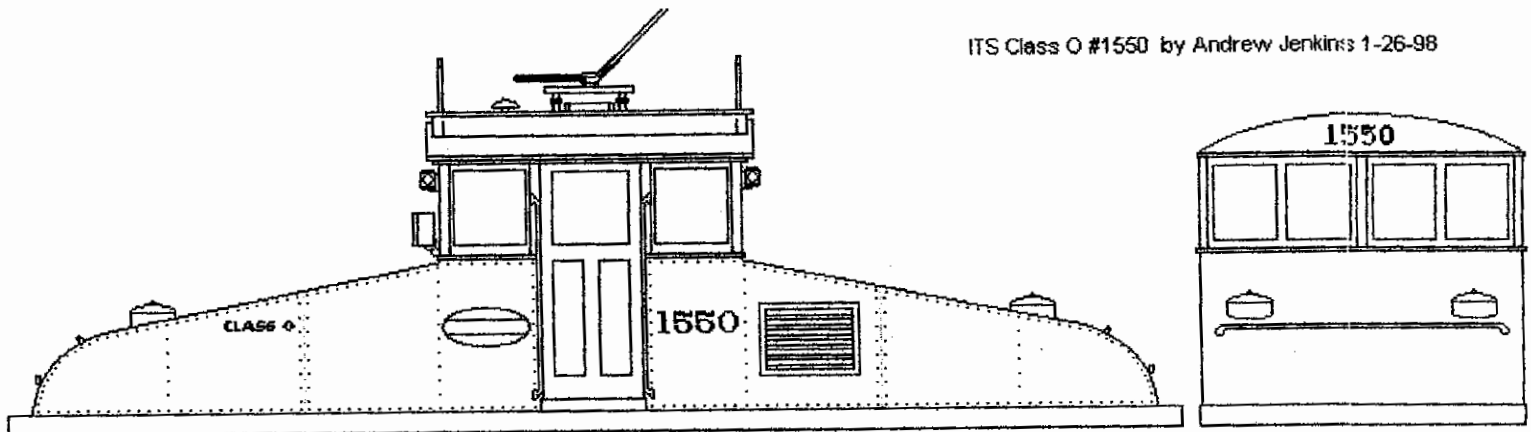

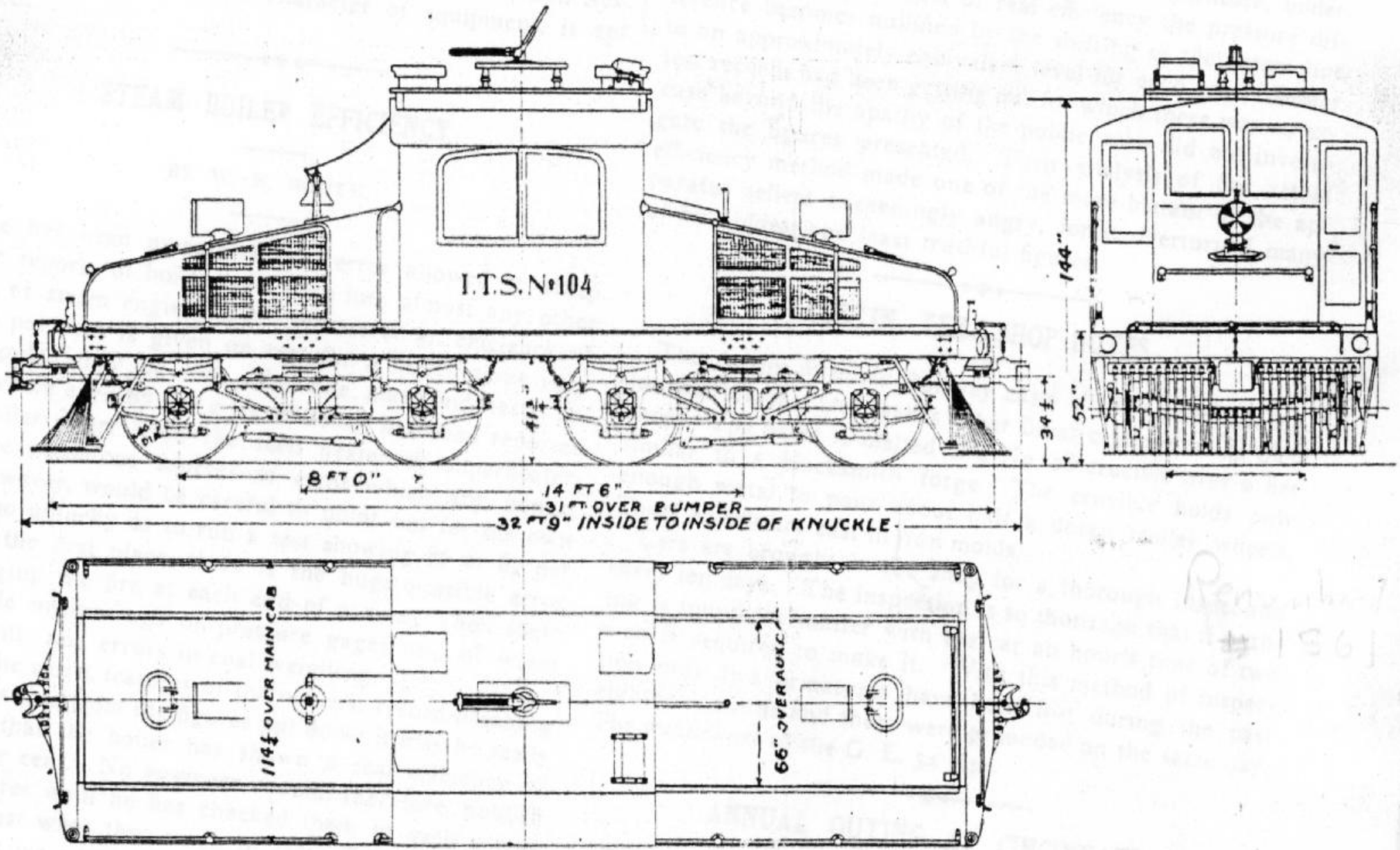
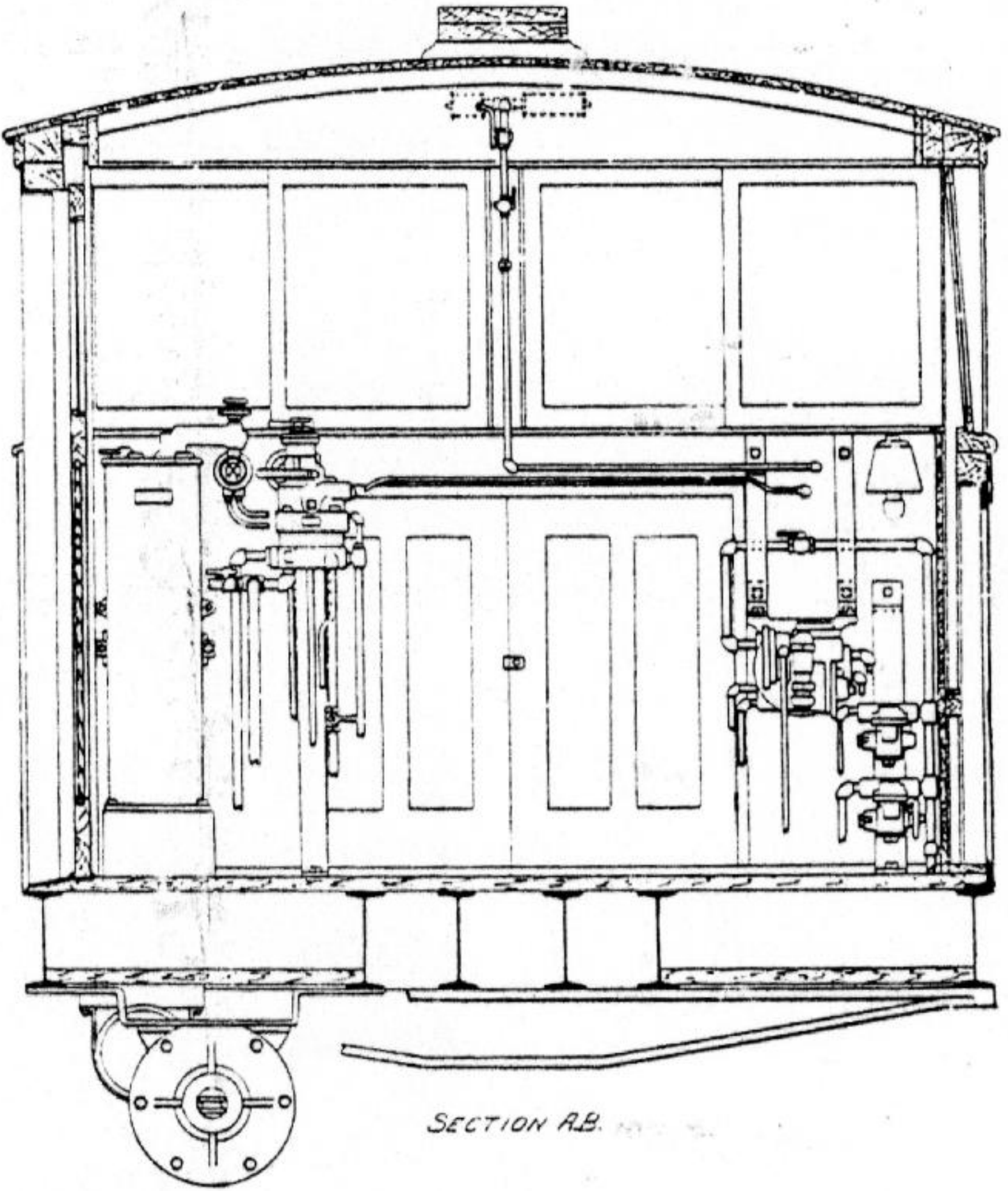
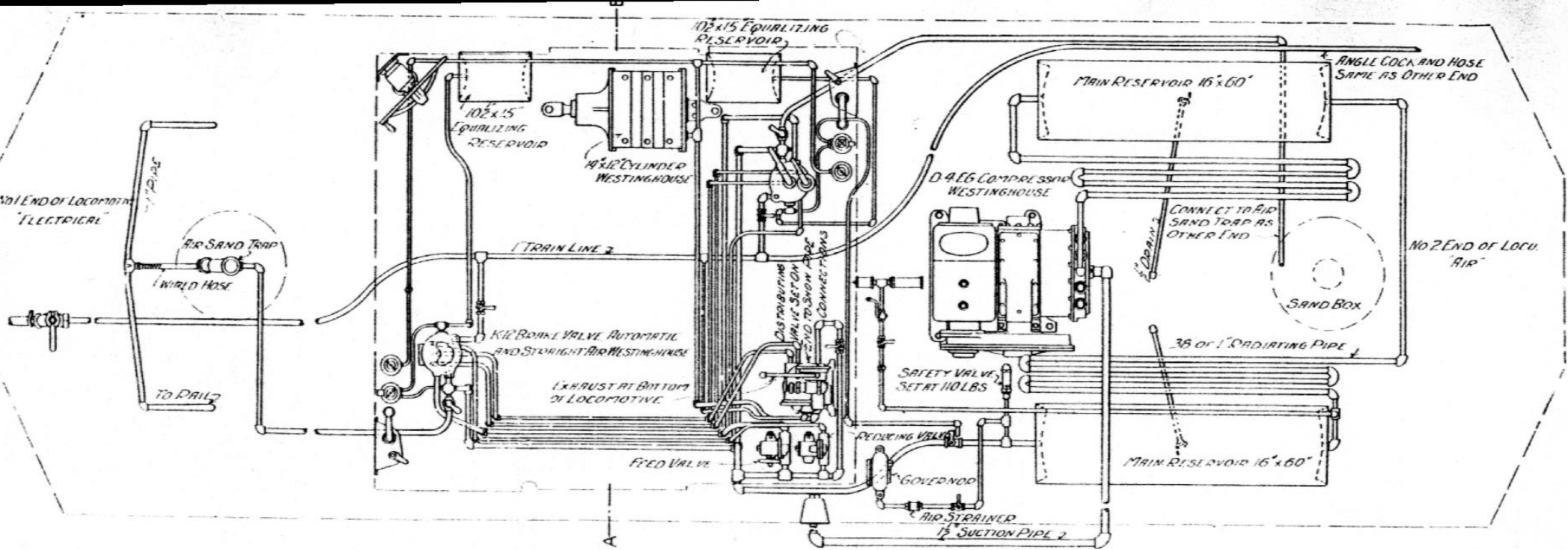

FIG. 27.—50-TON LOCOMOTIVE EQUIPPED WITH FOUR G E A-609 MOTORS



SECTION A.B.

Illinois Traction Locomotives—Sectional Elevation Through Cab.



Illinois Traction Locomotives—Plan of Braking Installation.

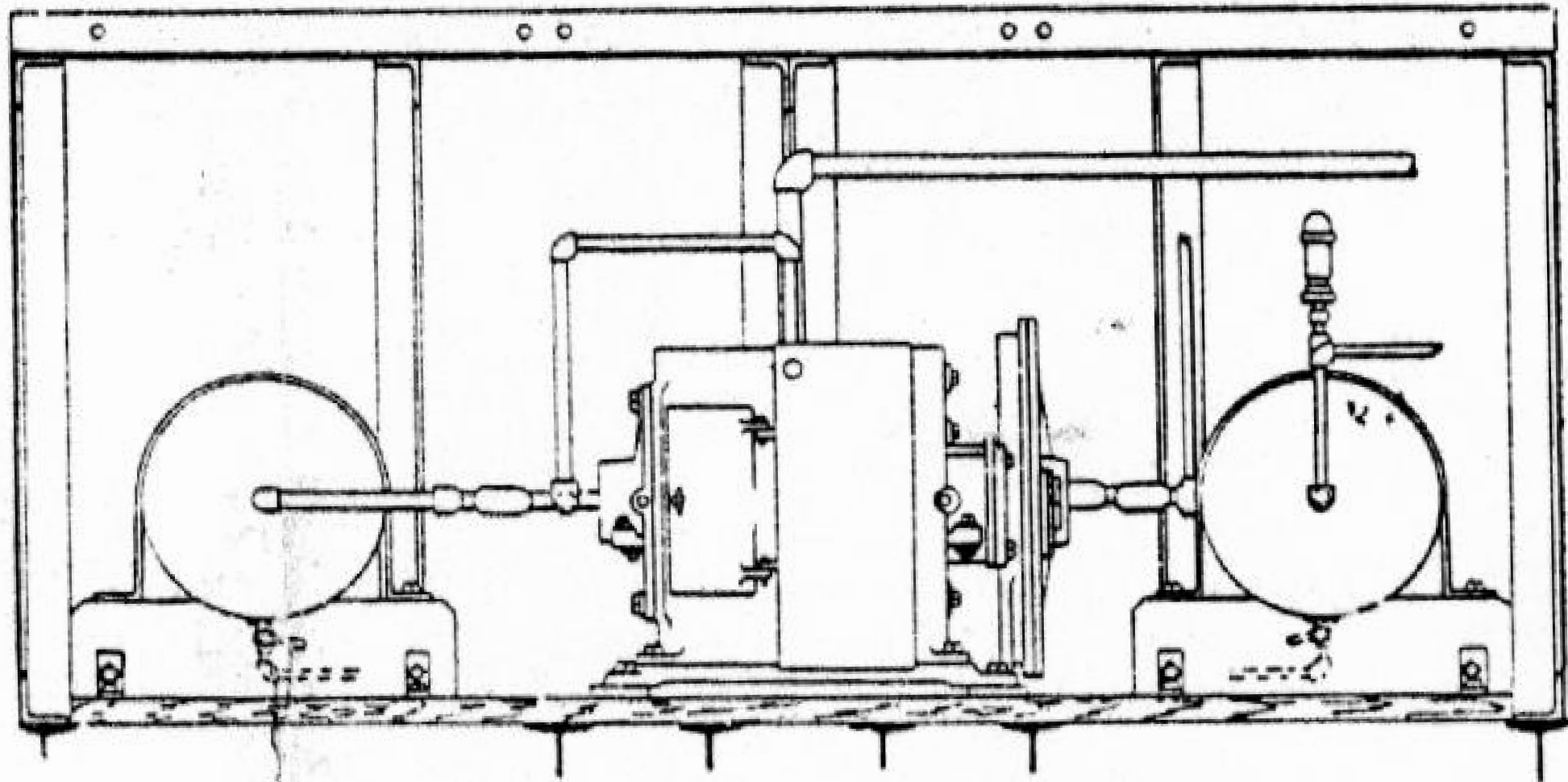

Illinois Traction Locomotives—Section at End Door.

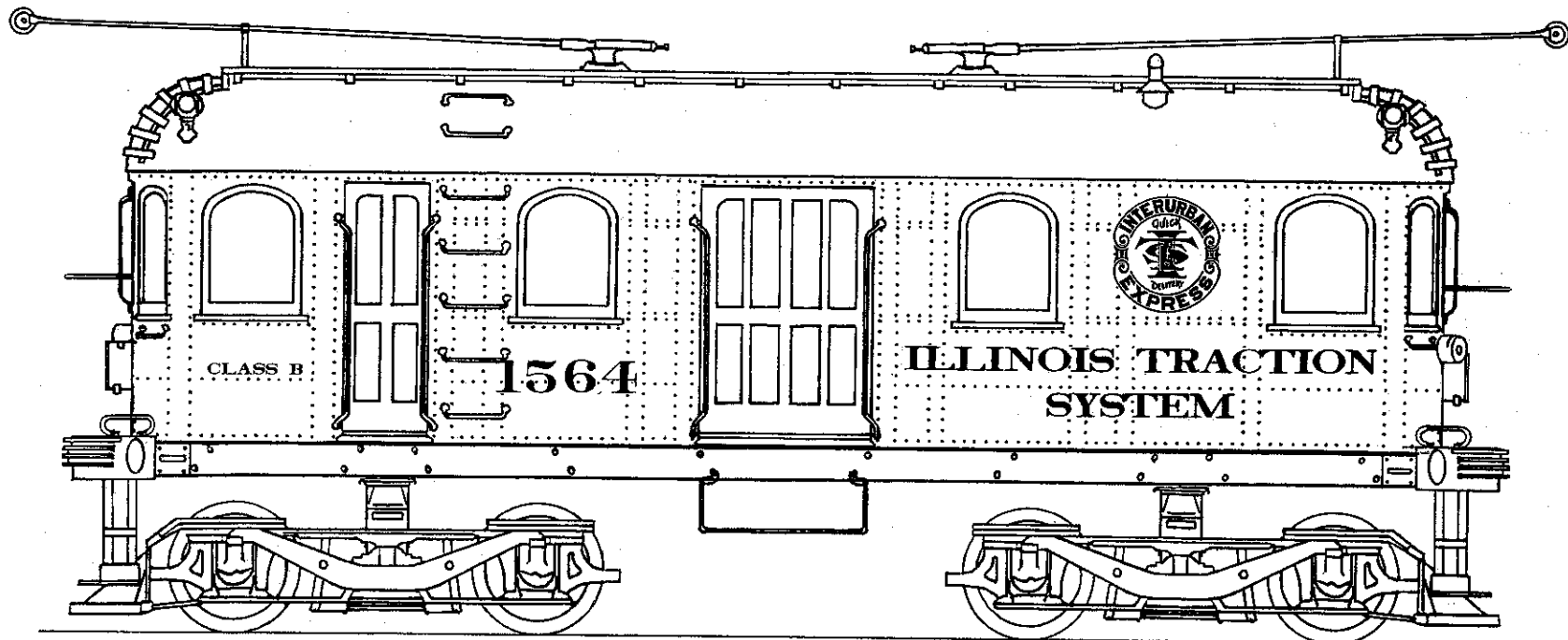

T Black

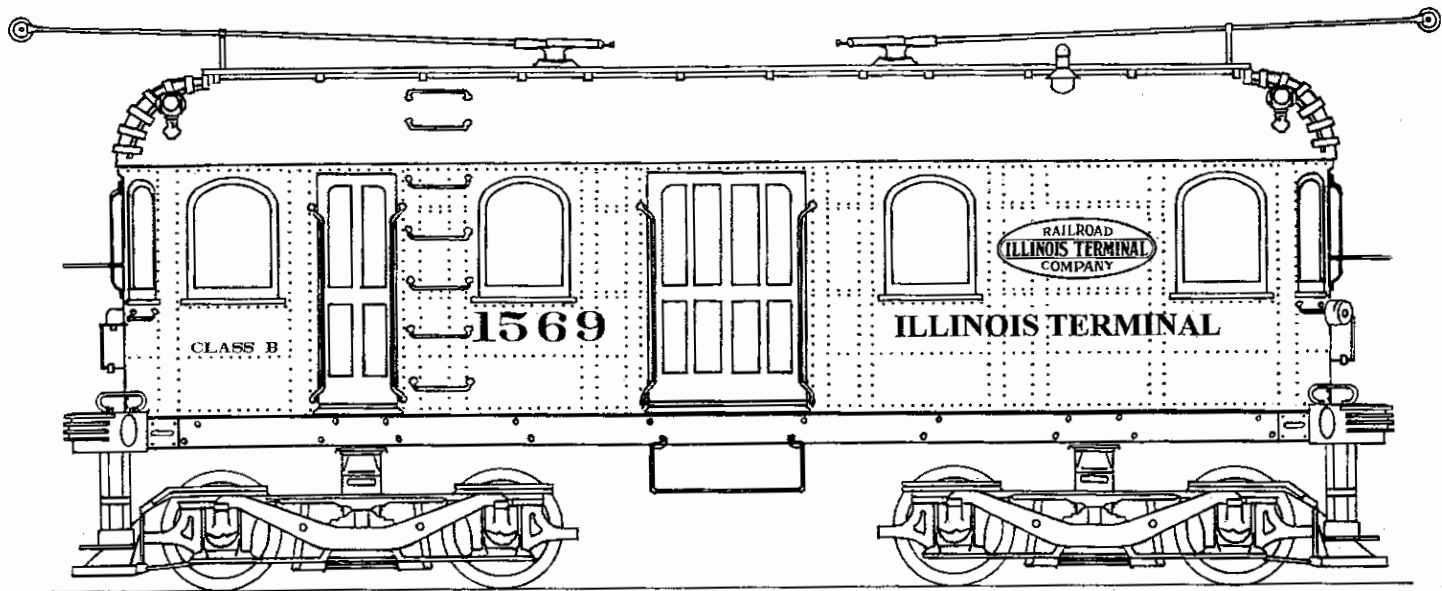

T. Black

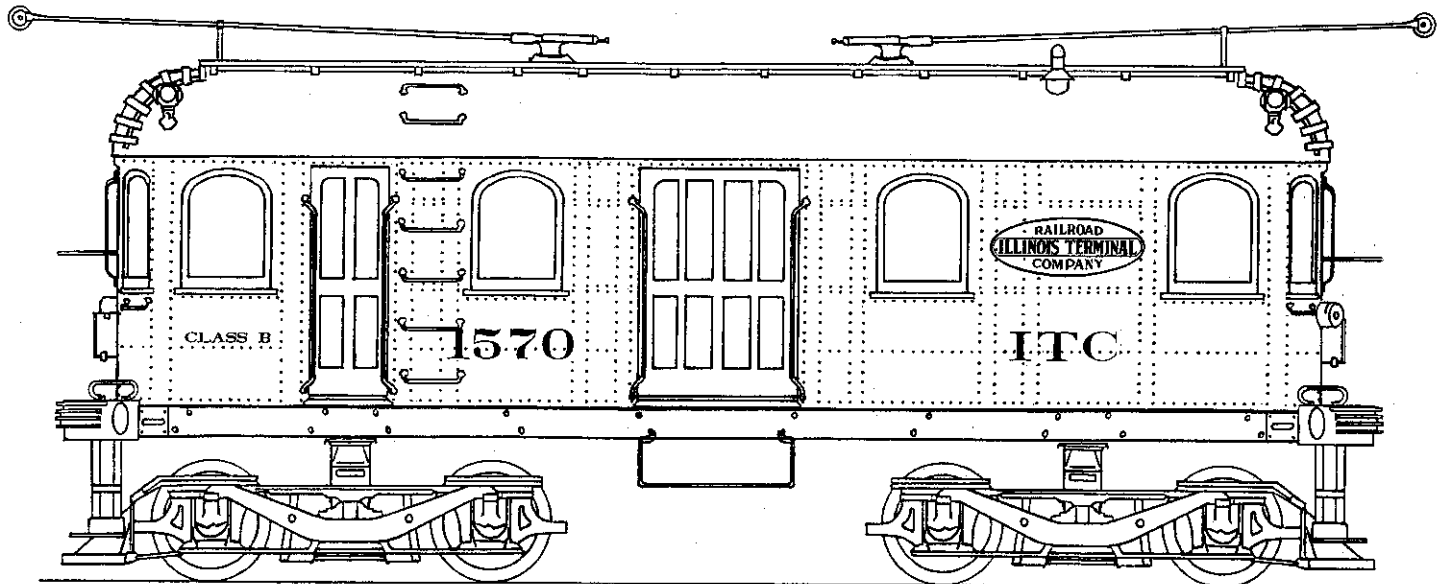

CLASS B

1570

RAILROAD  
ILLINOIS TERMINAL  
COMPANY

ITC

T. Black

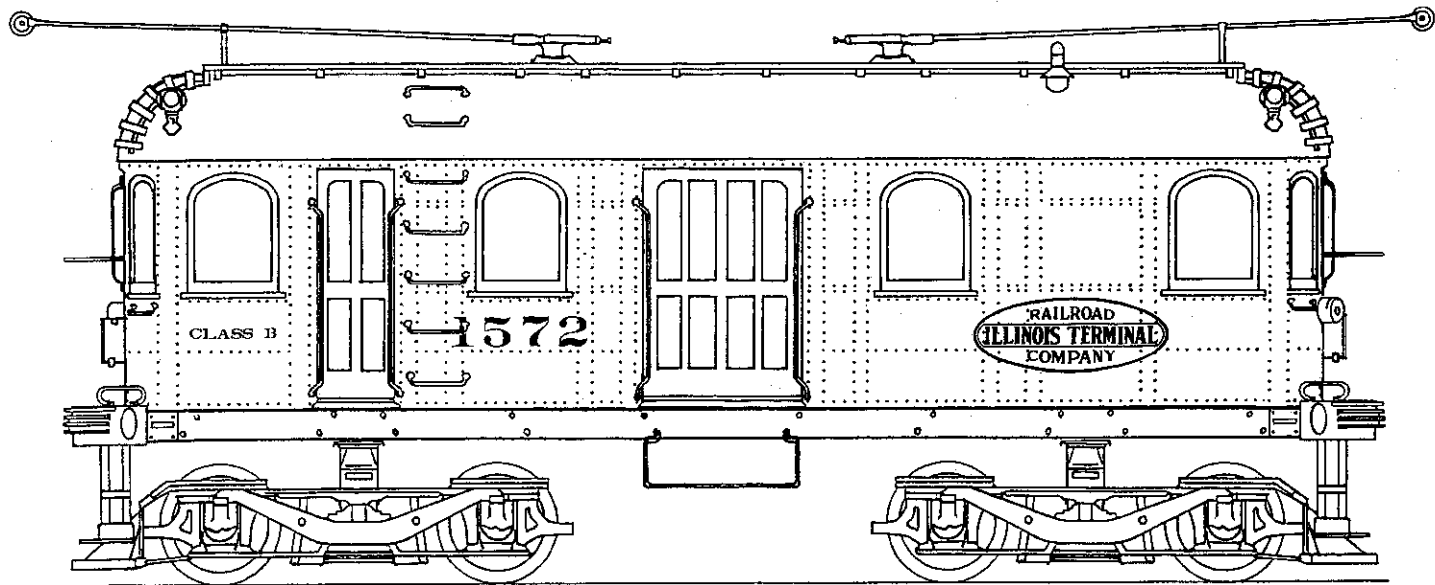
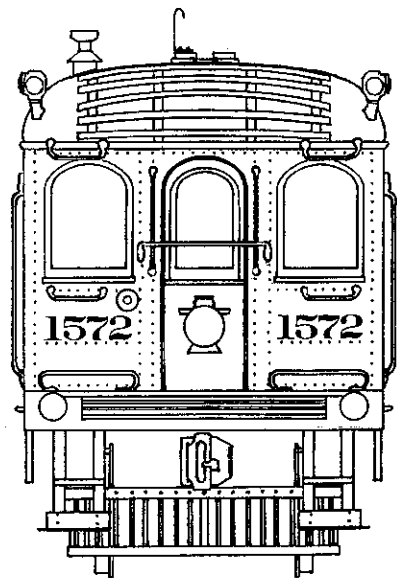

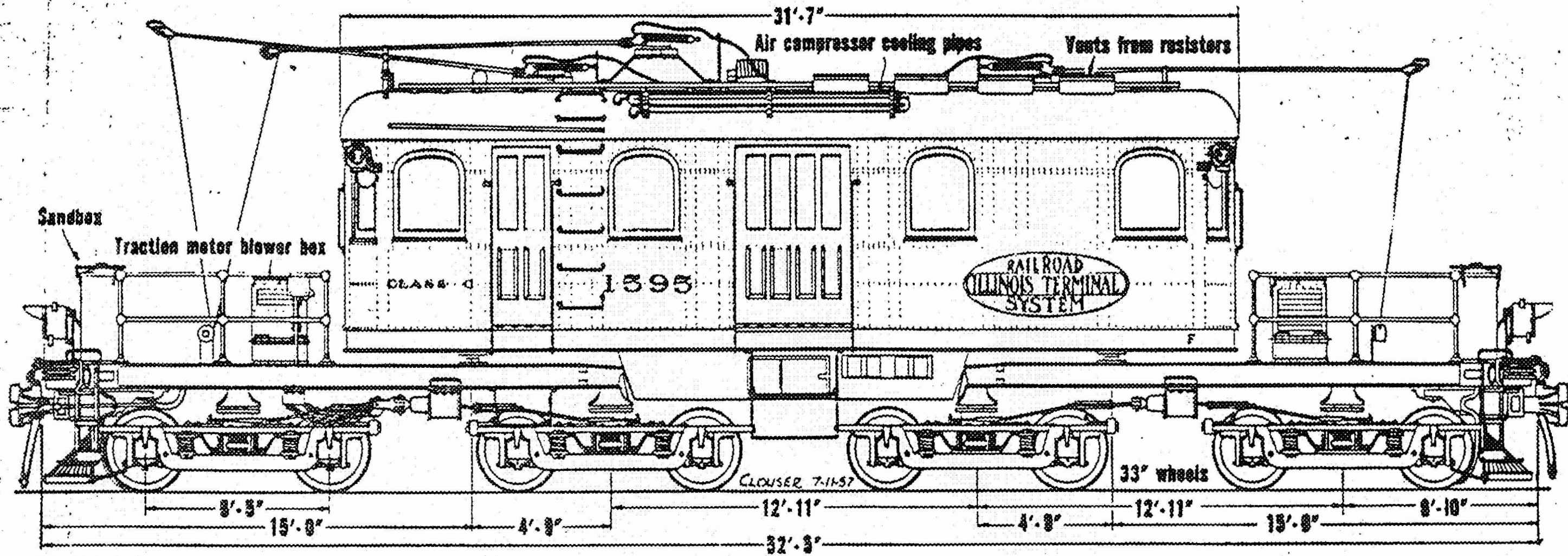

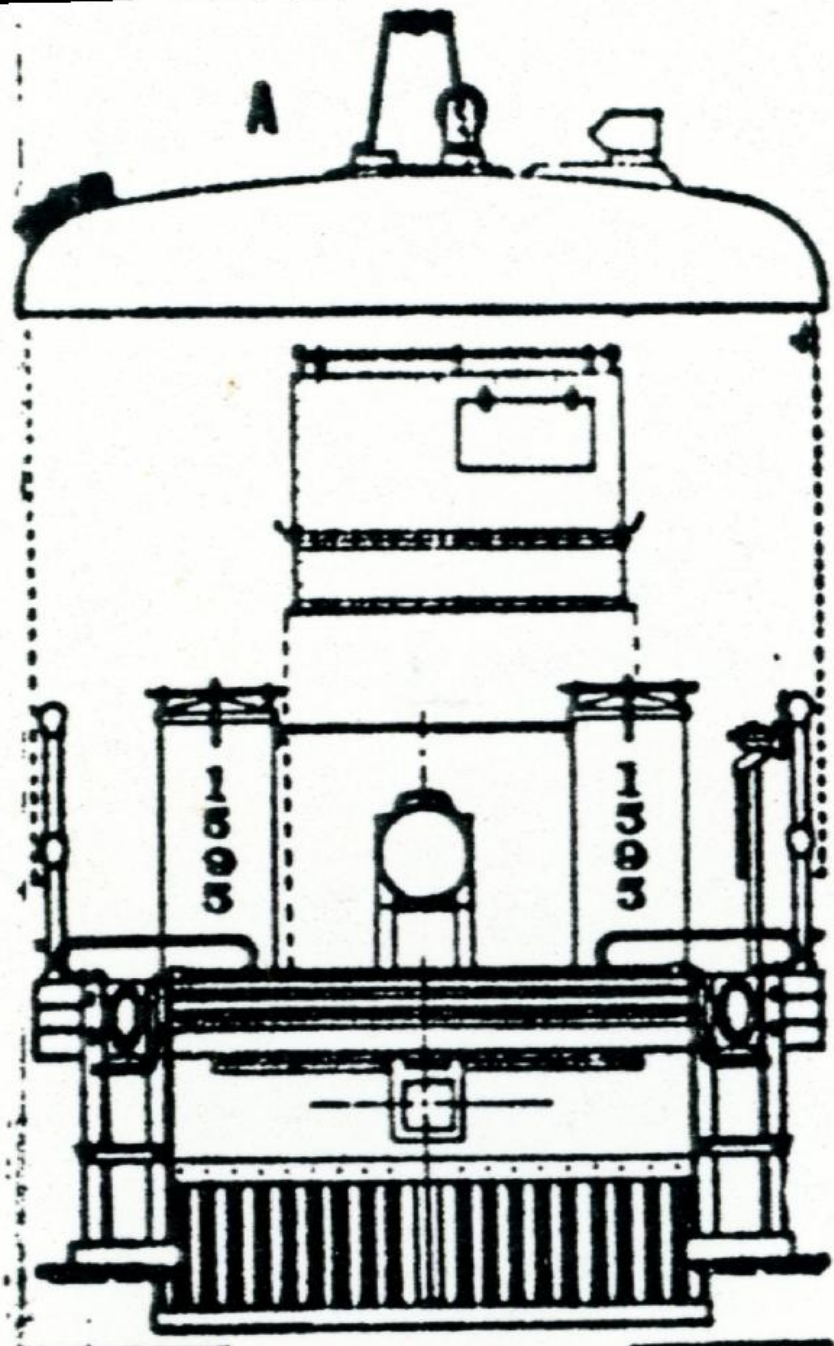

Front view

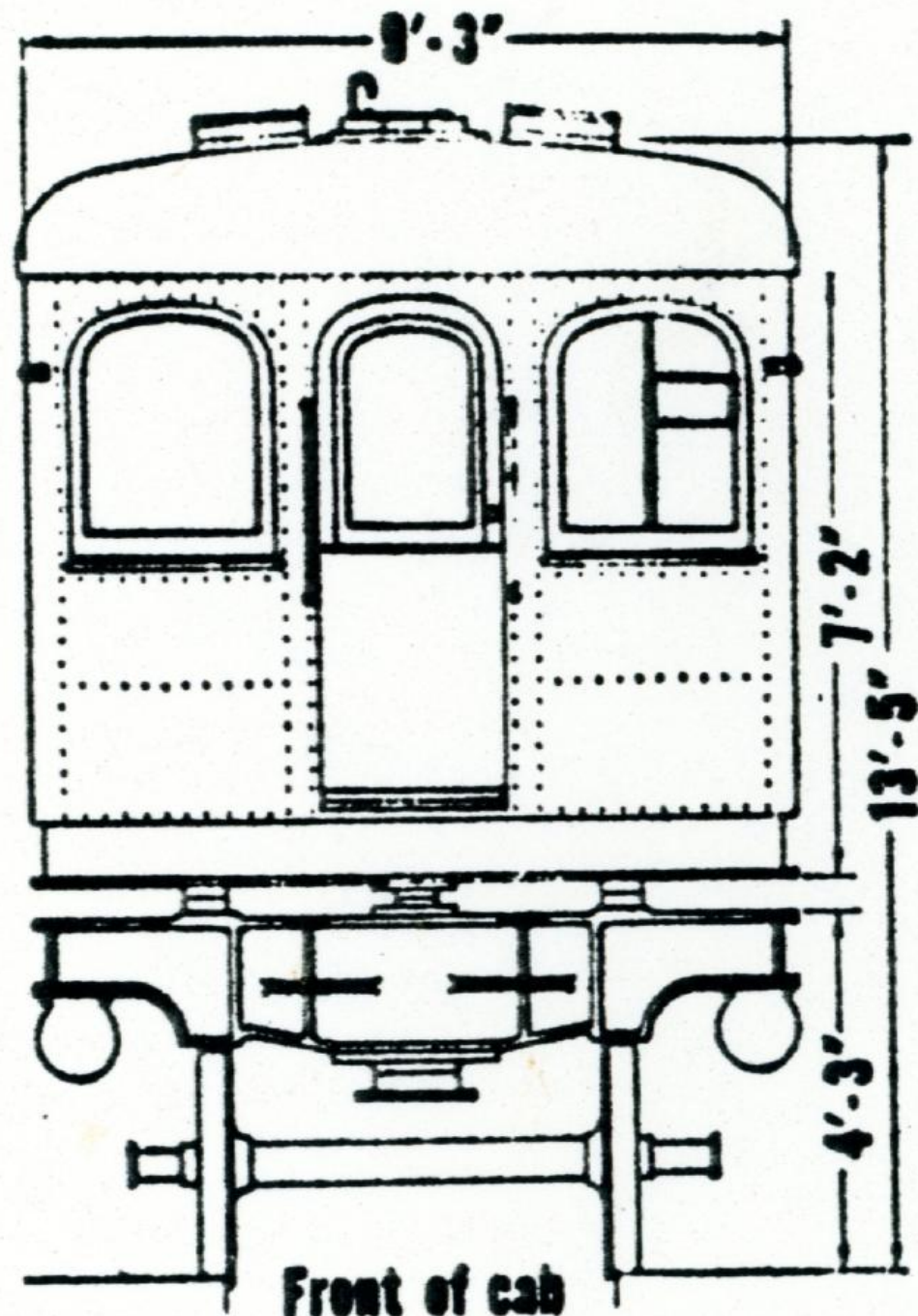

Front of cab

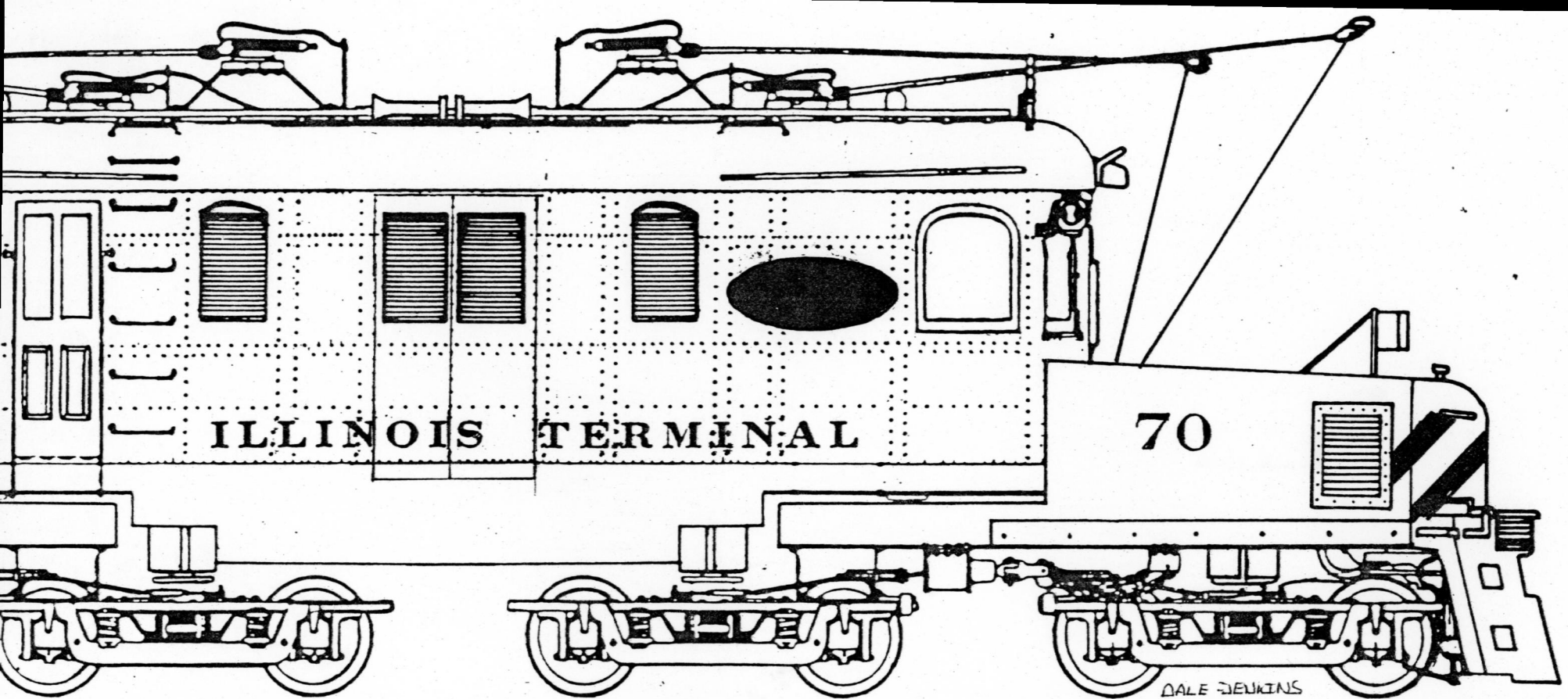

ILLINOIS TERMINAL

70

DALE JENKINS  
COLLECTION

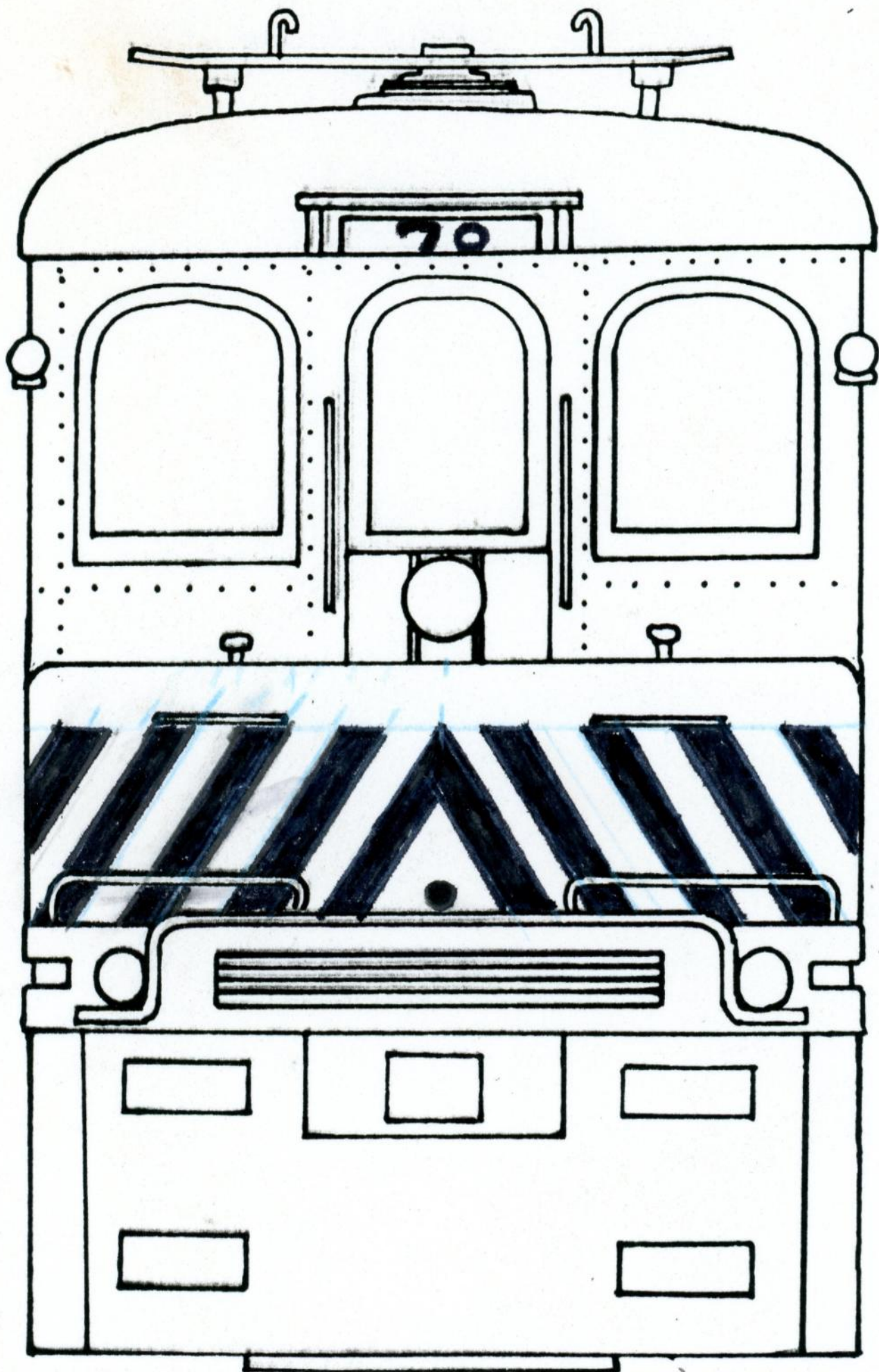

DALE JENKINS COLLECTION

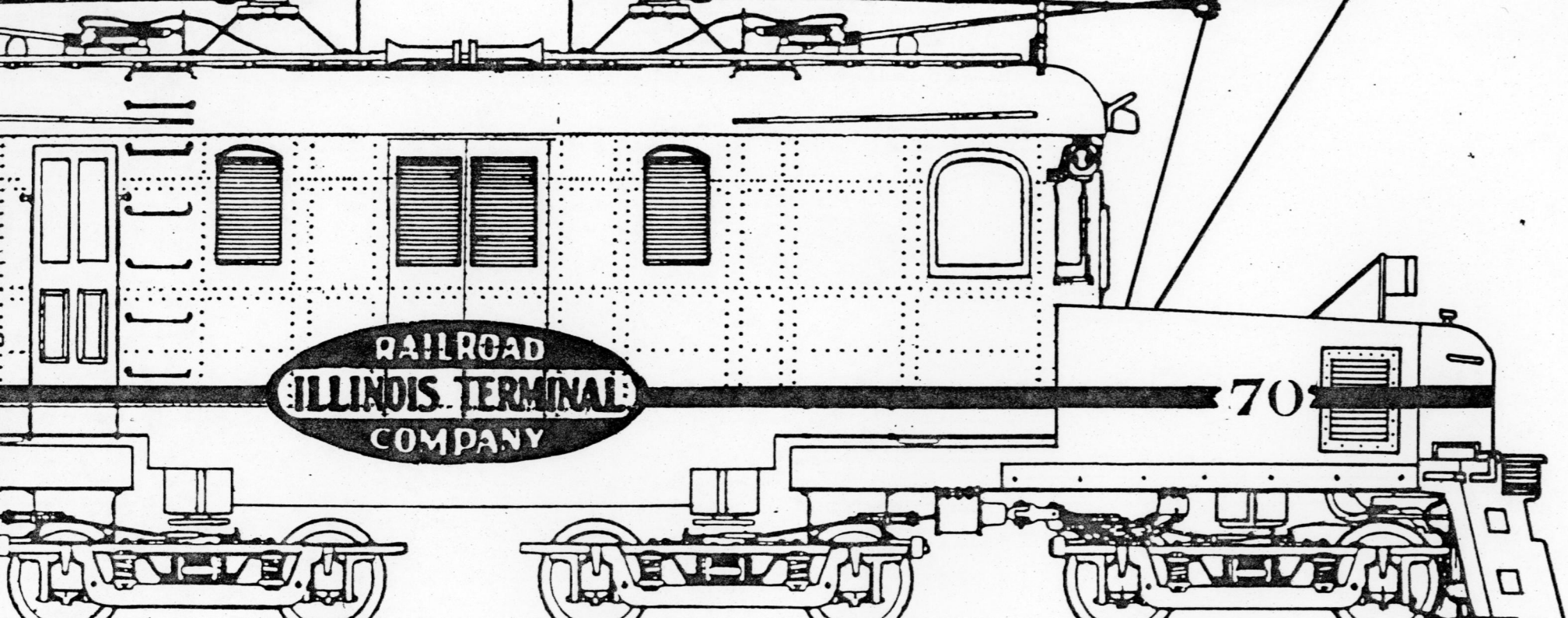

RAILROAD  
ILLINOIS TERMINAL  
COMPANY

70

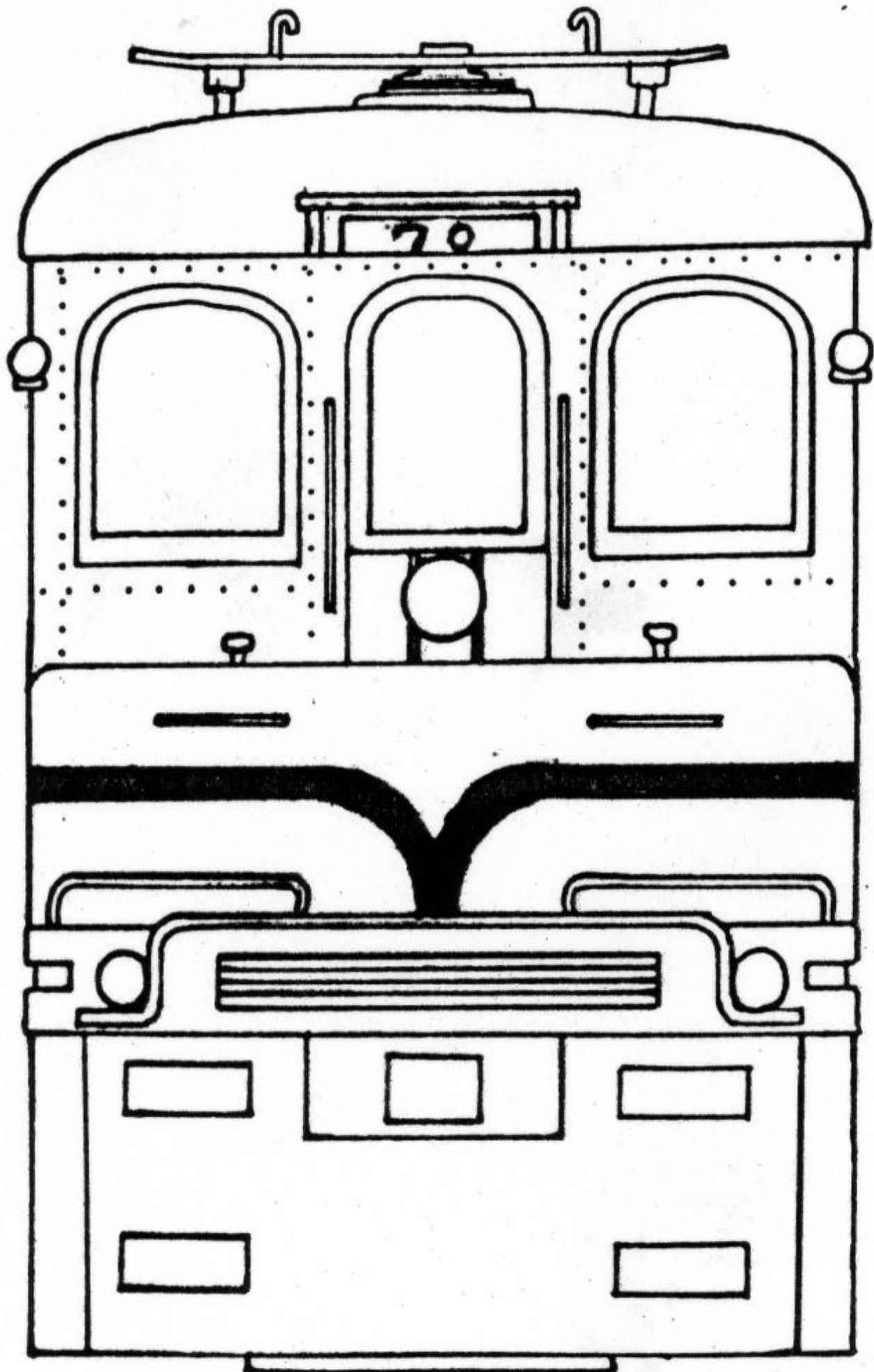

DALE JENKINS  
COLLECTION